

K PROMETNA OPREMA CESTE

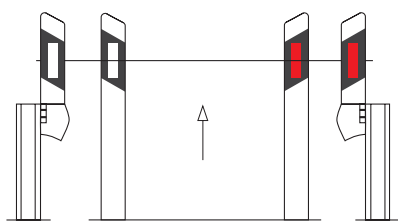

K 01**

Smjerkazni stupić
služi za označavanje
ruba kolnika

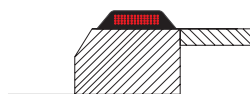

K 02

Smjerkazni stupić
za tunele

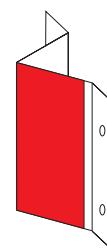

K 03***

Reflektirajuće oznake,
označuju rub kolnika umjesto
smjerkaznih stupića

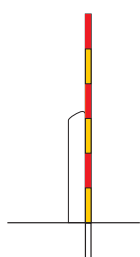

K 04

Štapovi za snijeg na
cesti u zimskim
uvjetima

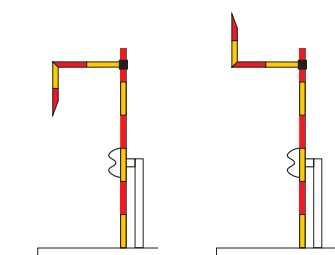

K 05

Štapovi za snijeg na
cestovnim građevinama
u zimskim uvjetima



K 06

Oprema za označivanje
vrha prometnog otoka

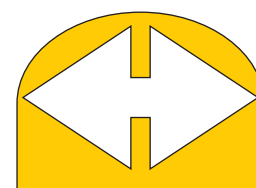

K 07

Oprema za označivanje
vrha prometnog otoka



K 08

Oprema za označivanje
vrha prometnog otoka



K 09***

Ploče za označivanje
zapreka na cesti
na lijevoj strani



K 10

Ploče za označivanje
zapreka na cesti
na lijevoj strani



K 11

Ploče za označivanje
zapreka na cesti na
desnoj strani



K 12

Ploča za označivanje
zavoja na cesti



K 13

Ploča za označivanje
zavoja na cesti



K 14***

Ploča za označivanje
oštrg zavoja na cesti sa
smjerom usmjeravanja
na desno ili na lijevo

K PROMETNA OPREMA CESTE

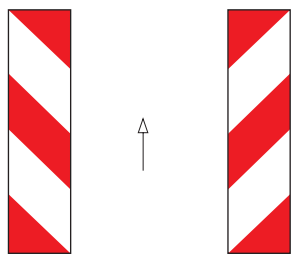

K 15

K 16

Ploča (bočne)
zapreke

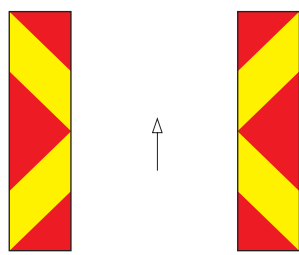

K 17***

K 18***

Ploča (bočne)
zapreke

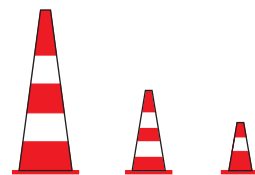

K 19

Stožac, služi za obilježavanje
mjesto kratkotrajnih radova
na cesti

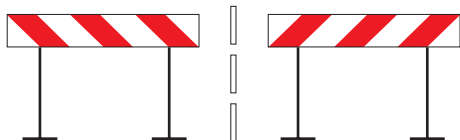

K 20

K 21

Branik za označivanje
zapreka na prometnoj
površini

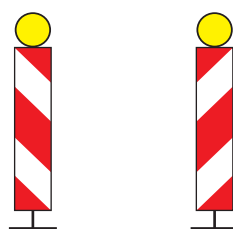

K 22

K 23

Ploča za označivanje
zapreka s treptačem
- radovi na cesti

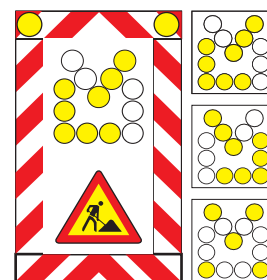

K 24

Pokretna ploča s
treptačima i znakovima
- izvođenje radova



K 25

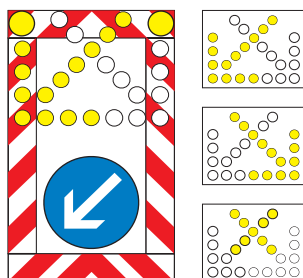

K 26

Pokretna ploča s
treptačima i znakovima
- izvođenje radova

Pokretna ploča s treptačima
i svjetlećim strelicama
- preusmjeravanje prometa



K 27

Pokretna signalna
ploča s promjenjivim
sadržajem



K 28

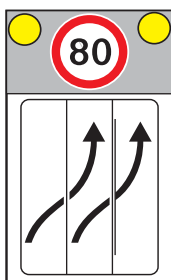

K 29

Pokretna signalna
ploča s promjenjivim
sadržajem

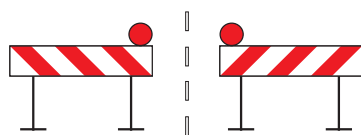

K 30

Crveno svjetlo na
pločama za označivanje
zatvorenog dijela ceste

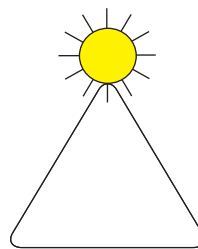

K 31

Trepćuće žuto svjetlo
služi za naglašavanje
prometnog znaka

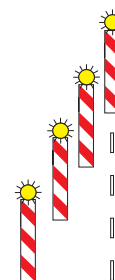

K 32

Niz trepćućih svjetala
preusmjerava promet

K PROMETNA OPREMA CESTE

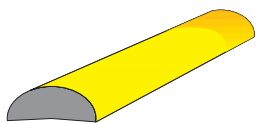

K 33

Reflektirajuća tijela utisnuta na rubnjak

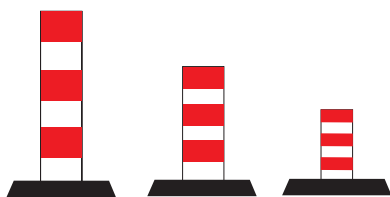

K 34

Markeri za razdvajanje smjerova vožnje

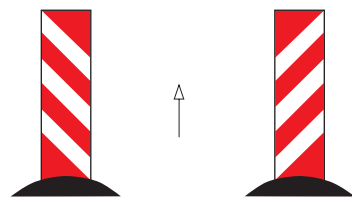

K 35

K 36

Markeri za razdvajanje smjerova vožnje



K 37

Delineatori za razdvajanje smjera vožnje

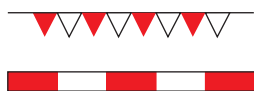

K 38

Zavjesice i trake za ograđivanje manjih prostora

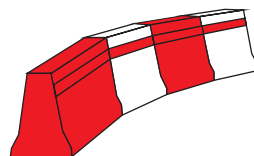

K 39

Razdvajajuće ograde za fizičko razdvajanje prometa suprotnih smjerova

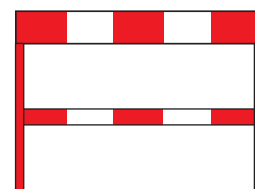

K 40

Rastezljive i složive ograde za zatvaranje manjih prometnih površina

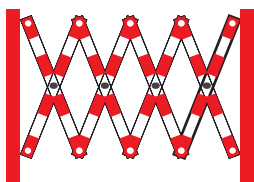

K 41

Rastezljive i složive ograde za zatvaranje manjih prometnih površina

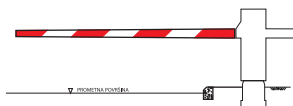

K 42

Branici kojima se na prijelazu ceste preko željezničke pruge u razini zatvara promet čitavom širinom ceste

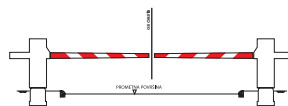

K 43

Branici kojima se na prijelazu ceste preko željezničke pruge u razini zatvara promet do polovice ceste

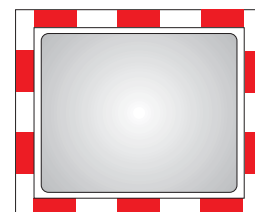

K 44

Prometno zrcalo pravokutnog oblika

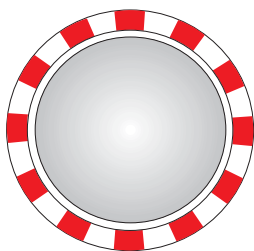

K 45

Prometno zrcalo kružnog oblika

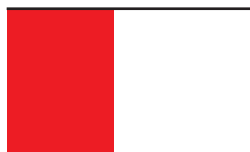

K 46

Zastavica označuje zabranu prometa



K 47

Zastavica označuje slobodan prolaz

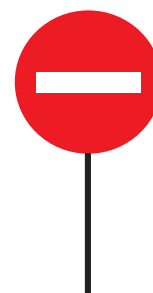

K 48

Zabrana prometa u jednom smjeru

K PROMETNA OPREMA CESTE

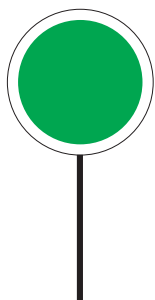

K 49

Slobodan prolaz

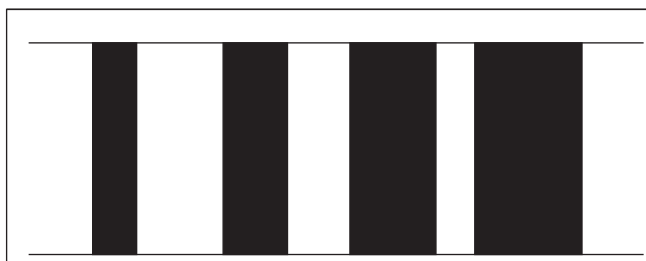

K 50

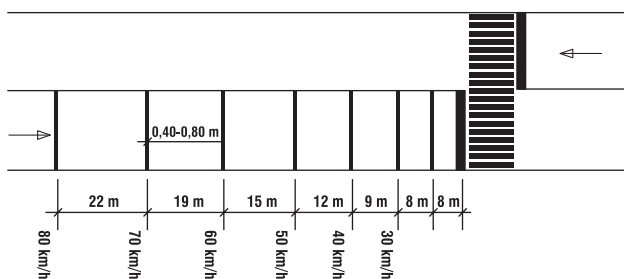

K 51

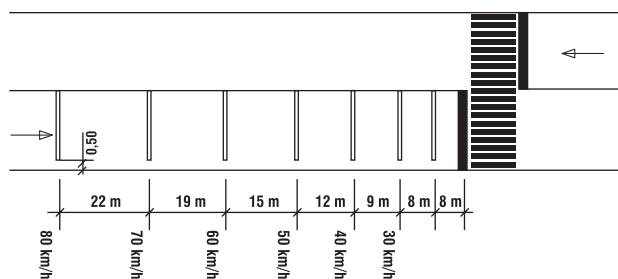

K 52

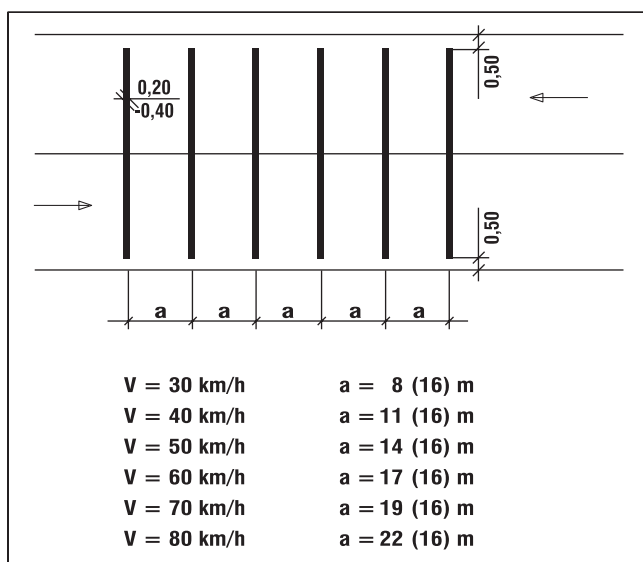

K 53

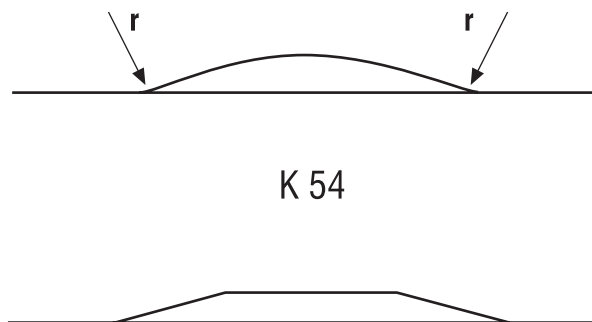

K 54



K 55

Prilazna brzina raskrižju V (km/h)	50 km/h	60 km/h	70 km/h	iznad 70 km/h
	Udaljenost od STOP crte (m)			
Prometni znak	1	2	3	4
A23 ili A24	-	150	150	150
B31	-	-	150	150
B32	100	150	150	200
D01, D02, D03 ili D04	150	150	200	250
A23 ili A24 sa E01	100	-	250	300